

- ⒹE Gebrauchsanleitung
- ⒻR Mode d'emploi
- ⒹL Gebruikershandleiding
- ⒼB User guide
- ⒺS Guía del usuario
- ⒾT Manuale di istruzioni
- ⒺE Bruksanvisning
- ⒸZ Uživatelská příručka
- ⒹK Brugervejledning
- ⒻI Käyttöohjeet
- ⒼR Οδηγός χρήστη
- ⒹO Brukerveiledning
- ⒼL Instrukcja obsługi

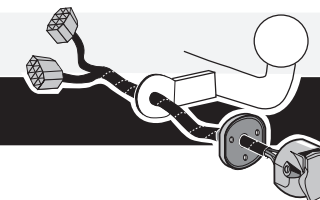

Partnr.: TO-139-DB

Gebrauchsanleitung	ⒹE	ⒸZ	Uživatelská příručka
Mode d'emploi	ⒻR	ⒹK	Brugervejledning
Gebruikershandleiding	ⒹL	ⒻI	Käyttöohjeet
User guide	ⒼB	ⒼR	Οδηγός χρήστη
Guía del usuario	ⒺS	ⒹO	Brukerveiledning
Manuale di istruzioni	ⒾT	ⒼL	Instrukcja obsługi
Bruksanvisning	ⒺE		



Toyota Rav 4 2006-

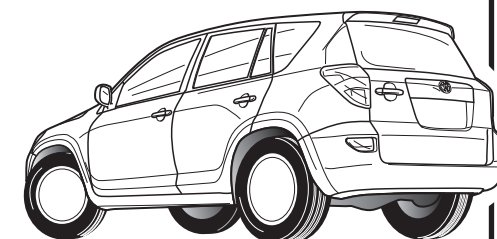
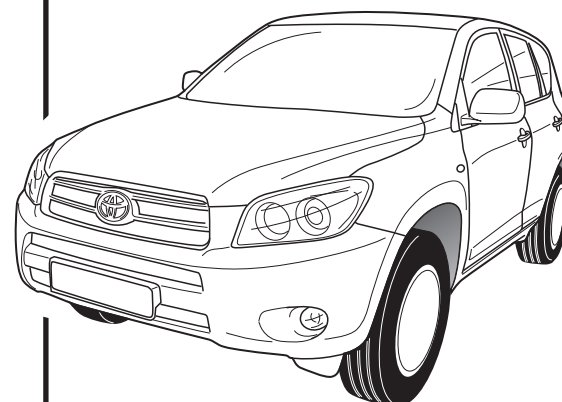

INFO

- DE Anschluss Steckdose
- FR Connection de la prise
- NL Contactdoos aansluiting
- GB Socket connection

- ES Conexión de la caja de enchufe
- IT Allaccio zoccolo
- SE Anslutning kontaktdosa

- CZ Objímkový konektor
- DK Stikdåse forbindelse
- FI Pistorasia liitäntä

- GR Υνοδοχή σύνδεσης
- NO Tilkobling koblingsboks
- PL Połączenie przez gniazdo

DIN/ISO 11446	1/L	2	2a	3/31	4/R	5/58-R	6/54	7/58-L	8	9	10	11	12	13	9
Pmax	21W	2x21W	2a	3/31	21W	52W	3x21W	52W	2x21W	180W/15Amp	180W/15Amp	11	12	13	9
DE	Gelb	Blau	Grau	Weiß	Grün	Braun	Rot (1,00mm ²)	Schwarz	Schwarz/ Rot	Braun/ Weiß	Rot (2,50mm ²)	Weiß	-	WeiB	WeiB
FR	Jaune	Bleu	Grís	Blanc	Vert	Marron	Rouge (1,00mm ²)	Noir	Noir/ Rouge	Marron/ Blanc	Rouge (2,50mm ²)	Blanc	-	Blanc	Blanc
NL	Geel	Blauw	Grijs	Wit	Groen	Bruin	Rood (1,00mm ²)	Zwart	Zwart/ Rood	Bruin/ Wit	Rood (2,50mm ²)	Wit	-	Wit	Wit
GB	Yellow	Blue	Grey	White	Green	Brown	Red (1,00mm ²)	Black	Black/ Red	Brown/ White	Red (2,50mm ²)	White	-	White	White
ES	Amarillo	Azul	Gris	Blanco	Verde	Marrón	Rojo (1,00mm ²)	Negro	Negro/ Rojo	Marrón/ Blanco	Rojo (2,50mm ²)	Blanco	-	Blanco	Blanco
IT	Giallo	Blu	Grigio	Bianco	Verde	Marrone	Rosso (1,00mm ²)	Nero	Nero/ Rosso	Marrone/ Bianco	Rosso (2,50mm ²)	Bianco	-	Bianco	Bianco
SE	Gul	Blå	Grå	Vit	Grön	Brun	Röd (1,00mm ²)	Svart	Svart/ Röd	Brun/ Vit	Röd (2,50mm ²)	Vit	-	Vit	Vit
CZ	Žlutá	Modrá	Šedá	Bílá	Zelená	Hnědá	Červená (1,00mm ²)	Černá	Černo/ Červená	Hnědo/ Bílá	Červená (2,50mm ²)	Bílá	-	Bílá	Bílá
DK	Gul	Blå	Grå	Hvid	Grøn	Brun	Rød (1,00mm ²)	Sort	Sort/ Rød	Brun/ Hvid	Rød (2,50mm ²)	Hvid	-	Hvid	Hvid
FI	Keltainen	Sininen	Harmaa	Valkoinen	Vihreä	Ruskea	Punainen (1,00mm ²)	Musta	Musta/ Punainen	Ruskea/ Valkoinen	Punainen (2,50mm ²)	Valkoinen	-	Valkoinen	Valkoinen
GR	Κίτρινο	Μπλε	Γκρι	Λευκό	Πράσινο	Καφέ	Κόκκινο (1,00mm ²)	Μαύο	Μαύο/ Κόκκινο	Καφέ/ Λευκό	Κόκκινο (2,50mm ²)	Λευκό	-	Λευκό	Λευκό
NO	Gul	Blå	Grå	Hvit	Grønn	Brun	Rød (1,00mm ²)	Svart	Svart/ Rød	Brun/ Hvit	Rød (2,50mm ²)	Hvit	-	Hvit	Hvit
PL	Żółty	Niebieski	Szary	Biały	Zielony	Brązowy	Czerwonny (1,00mm ²)	Czarny	Czarny/ Czerwonny	Brązowy/ Biały	Czerwonny (2,50mm ²)	Biały	-	Biały	Biały

- DE Sicherungen austauschen
- FR Remplacer les fusibles
- NL Zekeringen vervangen
- GB Changing the fuse
- ES Cambio de fusible
- IT Sostituire i fusibili
- SE Byte av säkringar
- CZ Výměna pojistky
- DK Udskiftning af sikringer
- FI Vaihdra varokkeet
- GR Αλλαγή ασφάλειας
- NO Skifte sikringene
- PL Wymienić bezpieczniki

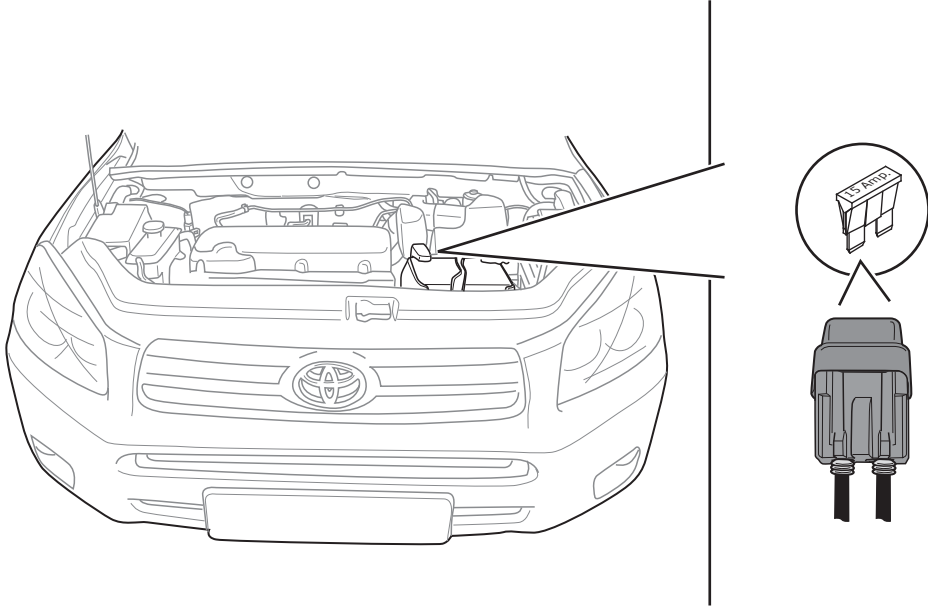

INFO : Storage

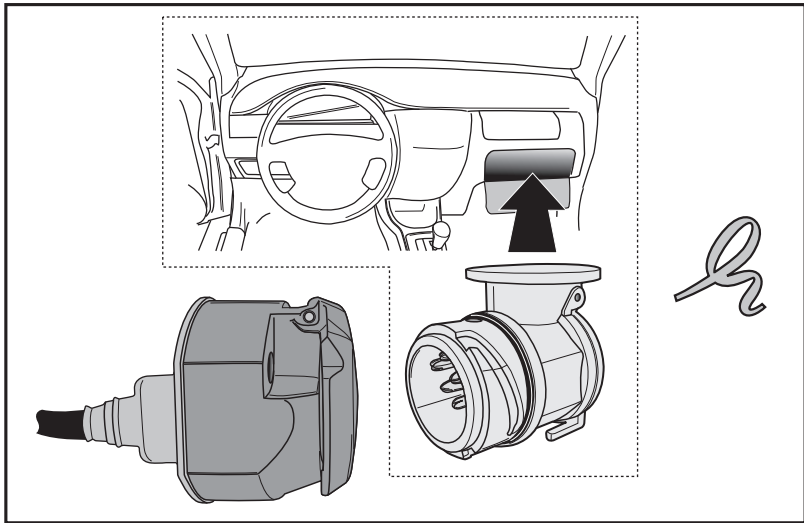
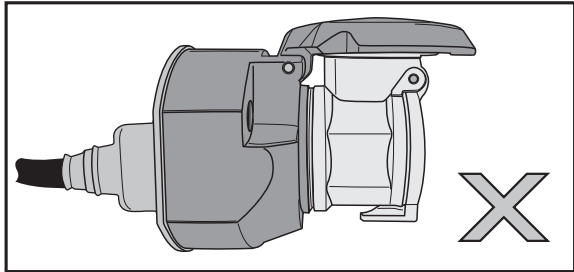
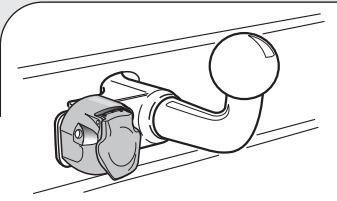
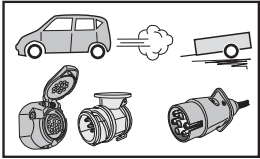

INFO

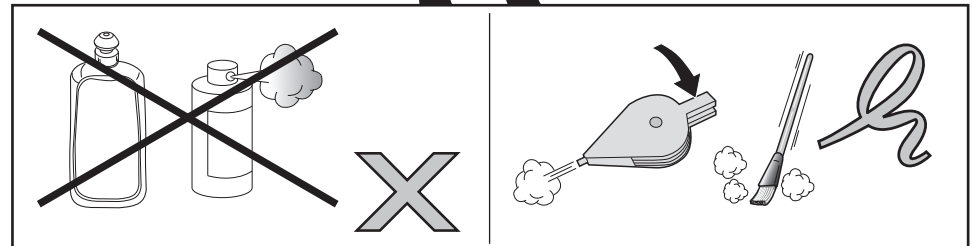
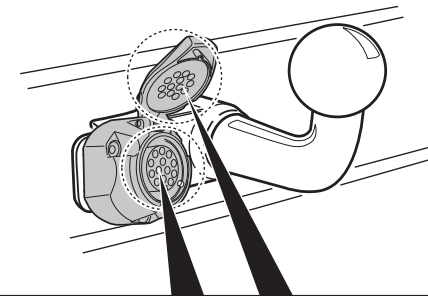
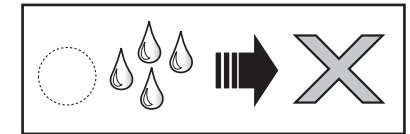
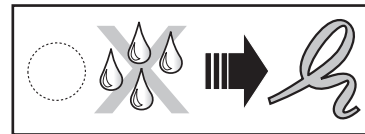
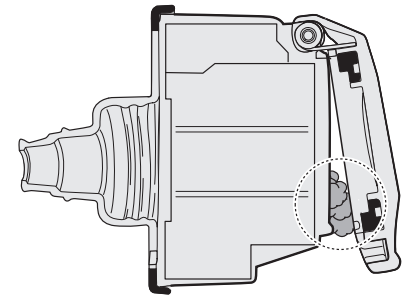
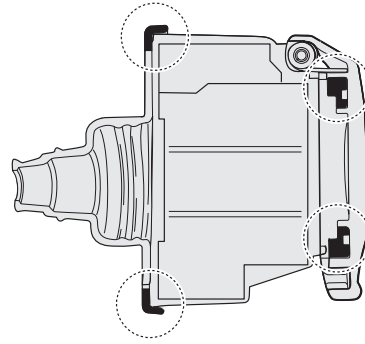
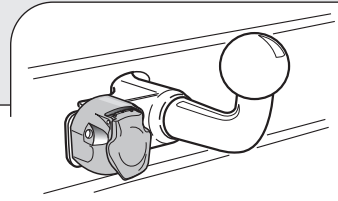
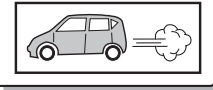

INFO : Ring.

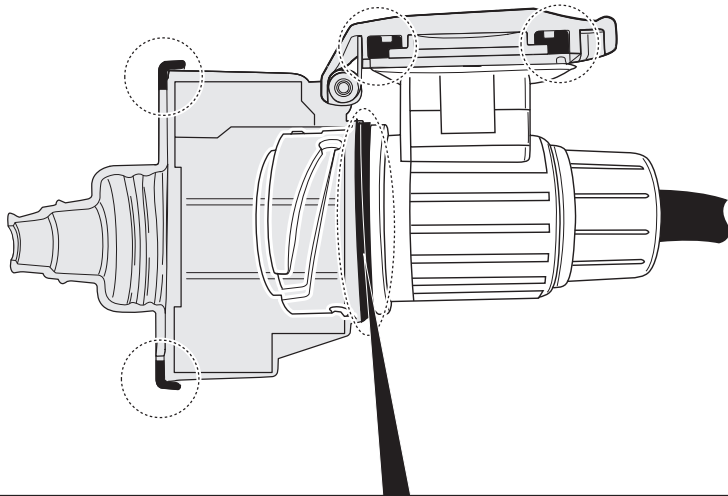
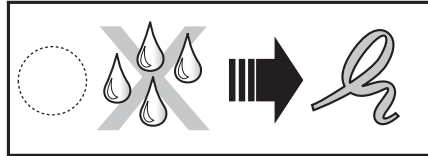
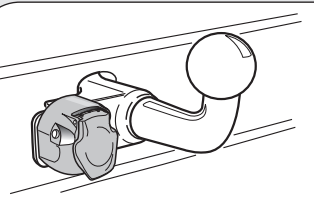
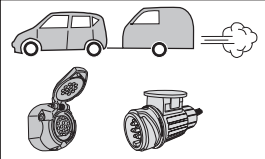

INFO

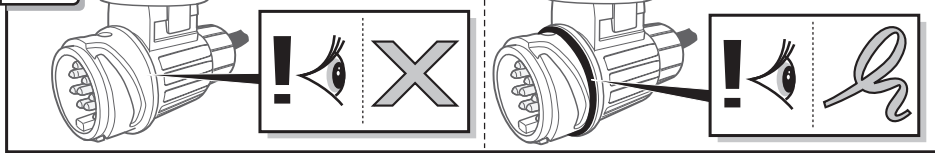

INFO : Adapt.

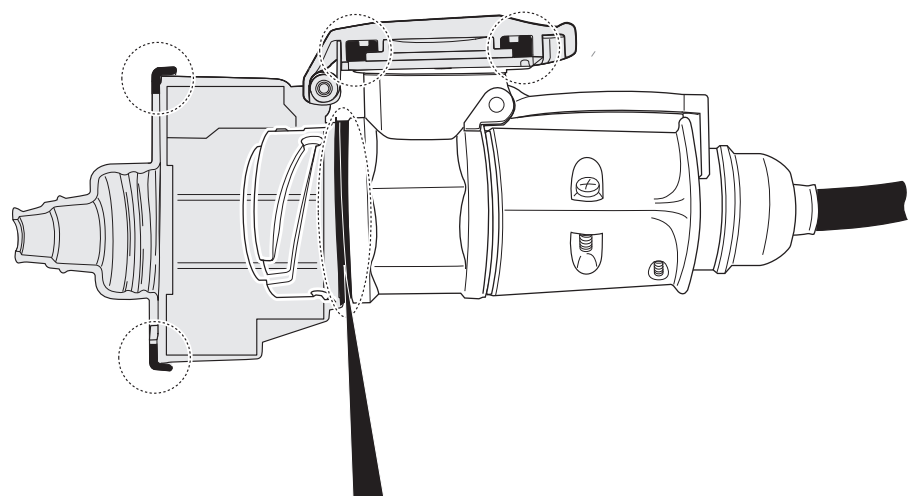
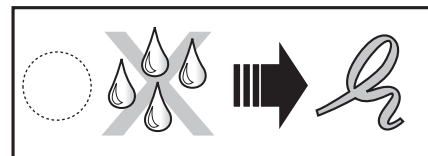
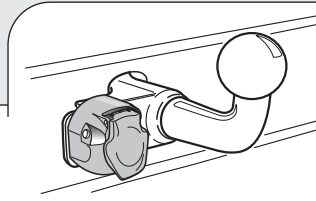
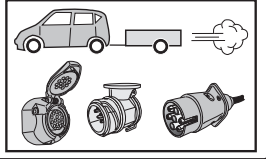

INFO

